

CREATING SOLUTIONS



PALSUN[®]

Flat Polycarbonate Sheet



Advertising



Construction



Fabrication



Glazing

Content

Company Profile	2
Introduction	3
The PALSUN® Product Range	3
Features at a Glance	4
Applications	4
Colors	5
Standard Dimensions	6
Characteristics	7
Typical Properties of PALSUN & PALTUF	7
Flammability	8
Optical Characteristics	9
Thermal and Optical Properties	10
PALSUN Solar Control	11
Weather Resistance	12
PALSUN Protects against the Harmful	13
Thermal Characteristics	14
Other Physical Characteristics	15
Chemical Resistance	16
Installation	17
Working with PALSUN & PALTUF	19

► Company Profile

Creating Solutions Worldwide

PALRAM is a multi-national, market leading manufacturer and distributor of extruded thermoplastic sheets made from polycarbonate, PVC and other materials. PALRAM has 600 employees around the world and operates from production, warehousing and distribution bases spread over 3 continents. PALRAM specialises in extruded thermoplastic sheets and creative solutions for agricultural, construction, advertising and DIY markets



Quality Commitment

- PALRAM Utilizes the potential of the SAP ERP system to strengthen coordination and to improve control of operations and quality control.
- PALRAM maintains its dedication to the highest internationally recognized quality standards.
- All PALRAM plants have achieved accreditation to ISO 9001:2000 Quality Assurance.

Close Customer Attention

- Many PALRAM advancements have come as a result of the close, working relationship with its customers.
- As PALRAM has grown larger, it has still retained its ability to respond to the demands and tailor-made requirements of its worldwide customers.
- PALRAM customers benefit from all new knowledge and developments emanating from PALRAM's ongoing R&D and receive continuous, reliable and fast comprehensive technical and technological support.



Innovation and Flexibility

- PALRAM's ongoing investment in state-of-the-art plant, machinery and technology, combined with in-house process and product innovations, has created a culture of continual product and plant development.
- Creating unique, high performance products
- Maintaining PALRAM's leadership in adapting, changing and modifying existing products to meet the demands of an ever growing and evolving market



► PALSUN® - A Modern Transparent Steel

The PALSUN flat, solid polycarbonate sheet is a segment of the extensive line of polycarbonate sheets manufactured by PALRAM. PALSUN combines a variety of features, allowing a wide range of uses. This highly versatile and long lasting material is the answer to virtually all of the designer and contractor's covering and glazing needs. PALSUN is also readily machined and formed into a wide variety of tough and durable fabrications.

Polycarbonate is one of the most advanced polymers in the field of plastics today. It offers an unequalled combination of properties which include strength, transparency, light weight, flexibility, durability, thermal resistance, fire resistance and many more.

PALSUN is transparent as glass, 200 times stronger and less than half the weight. In addition to all of these features, PALSUN can be bent either hot or cold (within limitations). PALSUN's absolute resistance to breakage qualifies it as the best existing safety glazing material in the world, with impact resistance that is impervious to hammer blows, stones, etc.

PALSUN is ideal for use in areas exposed to vandalism and in cases of high impact. As is evident in many buildings around the world, PALSUN offers the user possibilities and solutions where previously there were none. Its acoustic and thermal insulation capability, light weight and flexibility, as well as their superb blending into buildings and landscape, enable reduced design and construction costs. PALSUN constitutes a real breakthrough in design concepts and construction methods. They are manufactured to comply with European and U.S. standard specifications.

PALSUN® and PALSUN® UV2 Polycarbonate Sheets with a Co-extruded Ultraviolet (UV) Protective Layer

PALSUN flat polycarbonate sheets have a co-extruded UV protective layer on one side, while PALSUN UV2 (Formerly PALSUN Plus) offers co-extruded UV protective layer on both sides. This dramatically improves their UV resistance and other properties for outdoor applications. Installation of PALSUN will protect the people, plants, furniture and other objects from exposure to harmful solar UV radiation.

Note: PALTUF is the standard UV stabilized flat polycarbonate sheet, only without the protective layer.

► PALSUN® Product Range

- **PALTUF™** Flat solid polycarbonate for general purpose applications, best suitable for interior uses
- **PALSUN®** Flat solid polycarbonate with co-extruded UV protective layer on one side
- **PALSUN® UV2** flat solid polycarbonate with co-extruded UV protective layer on both sides
- **PALSUN® Embossed** Embossed with UV protective layer on one or both sides
- **PALSUN® FR** Possessing a higher fire resistance rating (UL 94-V-0) with co-extruded UV protective layer on one or both sides
- **PALSUN® Matte** Matte with co-extruded UV protective layer on one or both sides
- **PALSUN® Solar Control** Transmits selected percentages (20%, 35%, or 50%) of the light energy while keeping out the undesired heat component of radiation. The Solar Control feature is an integral part of the sheet. Co-extruded UV protective layer is available on one or both sides.
- **PALSUN® Foam** Flat foamed polycarbonate with co-extruded UV protective layer on one side
- **PALGARD™** Flat solid polycarbonate with high abrasion resistance and co-extruded UV protective layers on one or both sides.



PALSUN® products are also . . .

- Available in embossed, FR (Fire-retardant) or matte sheet variations.
- Polyethylene (PE) film protected on one or both sides.
- Supplied with a limited 10 year warranty available upon request.

► Features at a Glance

Lightweight

Less than half the weight of glass and 43% that of aluminum.

Transparent

Available in clear with up to 90% light transmission (the same as glass). Tinted, colored and embossed PALSUN is also available for a variety of light transmission, light diffusion and surface options.

Weather Resistant

PALSUN Sheets retain their characteristics for years under all conditions.

Thermal Insulation

Both PALTUF & PALSUN exhibit good thermal insulation.

Resistance to Chemicals

PALTUF & PALSUN Sheets are resistant to various chemicals and other substances. However, they should be prevented from coming in contact with certain materials, as specified by the manufacturer.

Easy to Mount

PALTUF & PALSUN Sheets are easy to work with and install.

Flexible, Formable, Machinable

PALTUF & PALSUN Sheets can be bent either hot or cold, can be thermoformed into an unlimited range of shapes, and can readily be machined and/or fabricated.

Easy to Clean

PALTUF & PALSUN Sheets can easily be cleaned with a 100% cotton cloth using generous amounts of mild detergent and water.



► Applications

Safe and secure glazing or shielding

- Safety glazing
- Protective see-through guards for machines in factories
- Glazing in schools and public buildings
- Construction of protective enclosures for bus stops and telephone booths
- Transparent protective shields for police and security forces
- Glazing in boats, trains, busses and planes
- Windshields for cars
- Eye protection visors for helmets

Construction

- Transparent acoustic barriers for roads and highways
- Roofing of stadiums
- Skylights
- Glazing of windows
- Construction of ceilings in halls and shopping centers
- Pergolas (covered patios or walkways)
- Sun rooms, conservatories and hobby greenhouses
- Roofs for buildings and halls
- Attic windows

Other Applications...

- Signboards fabricated with PALSUN sheets last for years.
- Light Fixtures incorporating PALSUN (PALSUN UV2 for exterior fixtures) opal, diffuser, or embossed sheets.
- Thermoformed, Vacuum Formed, Bent, and Fabricated Items

► Color Range

PALSUN & PALTUF are available in a wide variety of transparent, translucent, and opaque colors. Opaque colors do not transmit light. Transparent colors transmit light and images (and are clear or tinted). Clear and opaque sheets may have a glossy or embossed surface on one side. Opal or Diffuser sheets have 8% to 86% light transmission, depending on the thickness of the sheet. PALSUN Solar Control transmits fixed amounts of light (20, 35 or 50%) and will allow images to be viewed. The heat transmission is also reduced. Please refer to the table on page 12 for more detail.

A list of standard colors appears below. The colors depicted on this page are the closest reproduction of the actual color that is technically possible. Only sample chips* accurately characterize the colors in question.

Minimum order quantities may apply.

Consult with your PALRAM distributor to discuss your project and minimums required.

Transparent

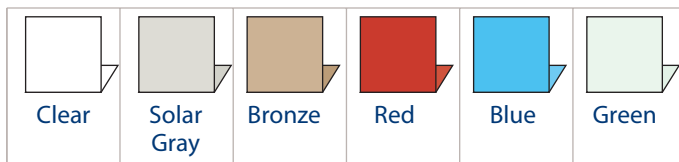

Translucent

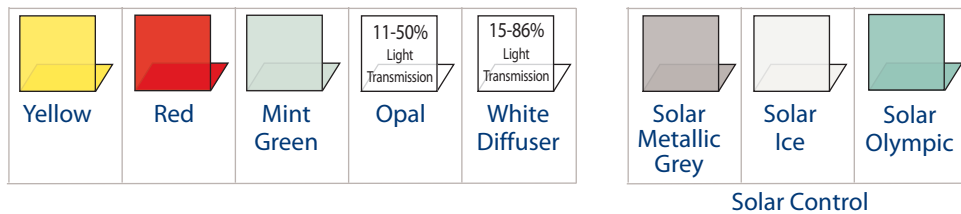

Solar Control

Opaque

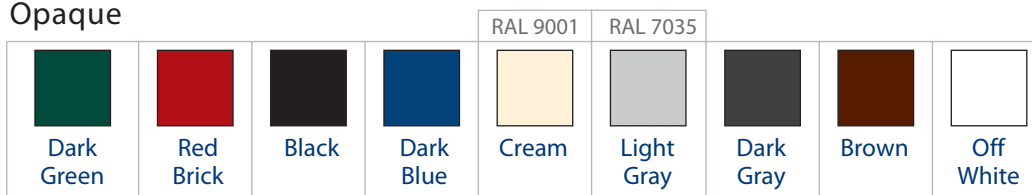

*Please consult with your local PALRAM distributor to:

- Receive a sample color chip.
- Order custom colors and/or light transmissions (subject to certain minimum quantities).

► Standard Dimensions

It is suggested that you refer to the Installation Section (page 18) for information that will assist you in selecting the proper sheet dimensions.

Avialable Thicknesses

Thickness (mm)	Smooth	Embossed	Matt
1, 1.5	x		x
2 to 6	x	x	x
8 to 12	x	x	

Width & Length

- 1250 mm x 2050 mm
- 1220 mm x 2440 mm
- 2050 mm x 3050 mm
- 2050 mm x 6050 mm

*Other dimensions are available with a special order.
Minimum quantity requirements may apply in certain cases.*



Quantity Per Pallet

Thickness	1250x2050	1220x2440	2050x3050
1	300	300	
1.5	200	200	
2	150	150	70
3	100	100	50
4	75	75	35
4.5	65	65	30
5	60	60	30
6	50	50	25
8	40	40	20
10	30	30	15
12	25	25	12



► Characteristics

PALSUN & PALTUF sheets possess electrical, mechanical, physical, optical and thermal properties, presented in the table below, that provide comprehensive solutions for the wide variety of applications depicted previously. The combination of these characteristics qualifies PALSUN & PALTUF sheets as a first class material.

Typical Properties of PALSUN® & PALTUF™ 3mm Sheets

	Property	Conditions (U.S. Customary) ^a	ASTM Method ^b	Units - SI (U.S. Customary) ^a	Value (U.S. Customary) ^a
Physical	Density		D-792	g/cm ³ (lb/ft ³)	1.2 (75)
	Water Absorption	24 hr. @ 23°C	D-570	%	0.15
Mechanical	Tensile strength at yield	10 mm/min (0.4 in./min)	D-638	MPa (psi)	65 (9,400)
	Tensile strength at break	10 mm/min (0.4 in./min)	D-638	MPa (psi)	60 (8,800)
	Elongation at yield	10 mm/min (0.4 in./min)	D-638	%	6
	Elongation at break	10 mm/min (0.4 in./min)	D-638	%	>90
	Tensile Modulus of Elasticity	1 mm/min (0.4 in./min)	D-638	MPa (psi)	2,300 (290,000)
	Flexural Modulus	1.3 mm/min (0.052 in./min)	D-790	MPa (psi)	2,600 (380,000)
	Flexural Strength at Yield	1.3 mm/min (0.052 in./min)	D-790	MPa (psi)	100 (14,500)
	Notched Impact Strength Izod	23°C (73°F)	D-256	J/ (ft-lbf/in.)	800 (15)
	Notched Impact Strength Charpy	23°C (73°F)	D-256	J/m (ft-lbf/in)	800 (15)
	Impact Falling Weight	3mm (0.12 in.) Sheet	ISO-6603/1b	J (ft-lbf)	158 (117)
	Rockwell Hardness		D-785	R scale / M scale	125 / 75
Thermal	Long Term Service Temperature			°C (°F)	-50 to +100 (-175 to +212)
	Short Term Service Temperature			°C (°F)	-50 to +120 (-175 to +250)
	Heat Deflection Temperature	Load: 1.82 MPa (264 psi)	D-648	°C (°F)	135 (275)
	Vicat Softening Temperature	Load: 1 kg (2.2 lb)	D-1525	°C (°F)	150 (300)
	Coefficient of Linear Thermal Expansion		D-696	mm/m °C (10 ⁻⁵ in./in. °F)	0.065 (3.6)
	Thermal Conductivity		C-177	W/m ² K (Btu-in./hr-ft ² -°F)	0.21 (1.46)
	Specific Heat Capacity		C-351	kJ/kg ² K (Btu/lb°F)	1.26 (0.31)
Optical	Haze	Clear Sheet	D-1003	%	<0.5
	Light Transmission	3mm (0.12 in.) Clear Sheet	D-1003	%	89
	Refractive Index	Clear Sheet	D-542		1.586
	Yellowness Index	Clear Sheet	D-1925		<1
Electrical	Dielectric Constant	50 Hz	D-150		3.0
		1 MHz	D-150		2.9
	Dissipation Factor	1 kHz	D-150		0.001
		1 MHz	D-150		0.01
	Dielectric Strength Short Time	500 V/s	D-149	kV/mm (V/mil)	>30 (>770)
	Surface Resistance	Keithley	D-257	Ohm	5.1x10 ¹⁵
	Volume Resistance	Keithley	D-257	Ohm-cm	1.3x10 ¹⁷

Notes

a. Conditions, units and values in U.S. Customary units are presented in the table within parentheses.

b. All the data presented in this table was obtained by following the indicated ASTM method except where another method is indicated.

► Flammability

The flammability classifications of PALSUN & PALTUF and PALSUN & PALTUF FR, based on tests carried out by certified independent laboratories, are listed below by standard.

PALSUN®	
Standard	Classification ^a
NSP 92501, 4	M1(1 mm)
NSP 92501, 4	M2(1.5 à 12mm)
BS 476/7	Class 1
DIN 4102	B1, B2
CSE RF 2/75/A, CSE RF 3/77	Class 1
UL Classified	V2 (File e221255)
ASTM D-635	CC1
PALSUN® FR	
Standard	Classification*
UL Classified	V-0 (File e221255)
ASTM D-2863-87	L.O.I. = 30
AU 1530.3-1982	Ignitability Index = 9
	Spread of Flame Index = 8
	Heat Evolved Index = 10
	Smoke Developed Index = 8

* All the above depends on thickness. For additional information please contact your PALSUN distributor.



► Optical Characteristics

All PALSUN products completely screen out potentially harmful ultraviolet (UV) light (discussed in detail on page 14) and a significant amount of infrared (IR) radiation. Over the visible range, a typical 3 mm (0.12 in.) PALSUN & PALTUF clear sheet transmits, on average, 90% of incident light. The % light transmission of a typical 3 mm (0.12 in.) PALSUN & PALTUF clear sheet is presented in the left-hand graph below. In the visible range of the spectrum, clear PALSUN & PALTUF sheets admit from 87% to 91% of the light, depending on the sheet thickness as shown in the upper left graph.

Clear PALSUN® & PALTUF™
% Light Transmission vs. Sheet Thickness

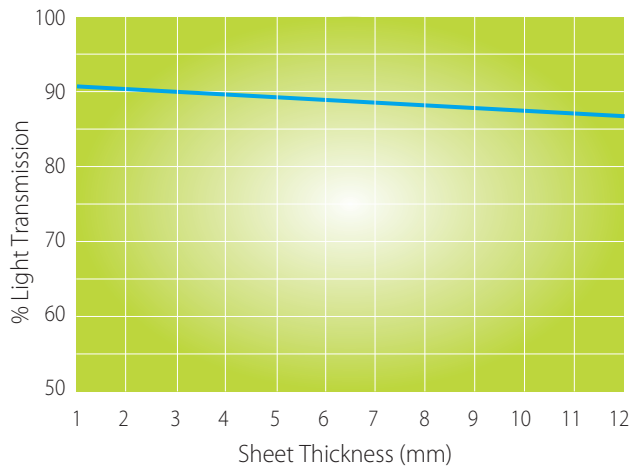

Clear 3mm PALSUN® & PALTUF™
% Light Transmission Versus Wavelength

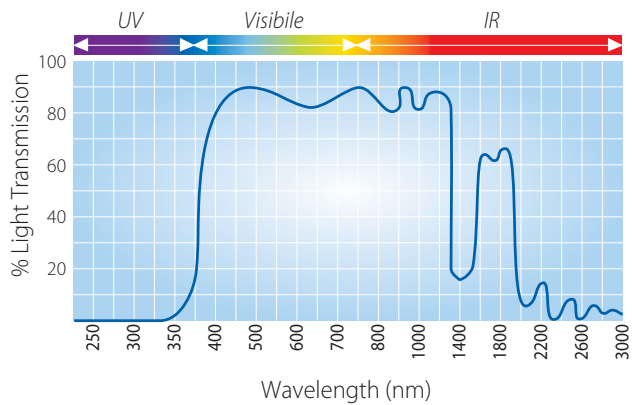

► Solar Transmission Properties

Various types of PALSUN can be used to help reduce energy costs throughout the year. Textured, tinted, opal, diffused, and new PALSUN SolarSmart™ sheets feature properties that affect energy efficiency beyond what is depicted on the next page. Each of these products transmit different amounts of direct light in varying levels of light diffusion, which may help to spread the light throughout the structure or enclosure. The products also offer different selectivity index (SI) values that determine how helpful they are in keeping the heat out while letting more “cool” light in. These products are recommended for installations in warmer geographic regions, or for installations that receive direct sun exposure for many hours each day. They help to diminish solar energy buildup and glare created by direct sunlight, reduce air-conditioning costs, and create a comfortable, well-lighted and pleasing ambience inside the structure.

PALSUN textured, diffused and opal sheets are also suitable for incorporation into light fixtures. They enable designers to deliver the exact quantity and quality of light desired.

PALSUN® Tint (3mm sheet)	% Light Transmission	% Total Solar Reflection	% Solar Heat Gain	Shading Coefficient	Selectivity Index
Clear	90	14	84	1.00	1.07
Opal	30	60	40	0.46	0.85
Bronze	50	35	65	0.75	0.92
Bronze	35	44	56	0.64	0.83
Bronze	20	54	46	0.52	0.71
Solar Grey	50	35	65	0.75	0.93
Solar Grey	35	44	56	0.64	0.83
Solar Grey	20	55	45	0.51	0.74
Solar Control	50	44	56	0.64	1.04
Solar Control	35	52	48	0.54	1.00
Solar Control	20	67	33	0.36	1.11
SolarSmart™ Grey	55	44	56	0.66	1.30
SolarSmart™ Blue	50	43	57	0.65	1.21
SolarSmart™ Green	70	40	60	0.69	1.55

*Information on additional products is available upon request

Terminology utilized in the table

Solar Radiation

The solar spectrum ranging from 300 nm to 2400 nm. Included are UV, visible and NIR radiation.

Visible Light Radiation

The portion of the light spectrum whose wavelength ranges from 400 nm to 780 nm.

Shading Coefficient (ASTM E424-71)

The ratio of the total solar radiation transmitted by a given material to that transmitted by normal glass, whose light transmission is 87%. It can be approximately calculated by:

$$SC = 1.15 \times (\%ST + (0.27 \times \%SA)) / 100$$

$$\%ST + (0.27 \times \%SA) = \%ST_t$$

$$SC = 1.15 \times ST_t / 100$$

Selectivity Index

The ratio of light and solar transmissions. This coefficient describes the product's solar efficiency. $SI = LT / ST$

% Light Transmission (ASTM D-1003)

Percentage of incident visible light that passes through an object.

Total Solar Transmission (%STt)

The percent of incident solar radiation transmitted by an object which includes the direct solar transmission plus the part of the solar absorption reradiated inward.

Total Solar Reflection (%SRt)

The percent of incident solar radiation rejected by an object, which includes the solar reflectance plus the part of the solar absorption, reradiated outward.

$$\%ST_t + \%SR_t = 100\%$$

► PALSUN® Range of Heat-Blocking Products

As can be seen in the previous table, PALSUN Solar Control (or Solar Metallic Grey) possesses the lowest shading coefficient and conversely the coolest temperatures, at a given level of light transmission. The solar control is integrated. There is no chance of a laminated layer peeling off. To illustrate the advantage of solar control in fighting heat buildup, the figures below compare a 20% Light Transmission Solar Gray sheet with a 20% Light Transmission Solar Control Sheet. First note that both sheets practically block 100% of the UV radiation and offer total protection to a person under the sheets. Comparing the absorption spectrum, it becomes apparent that the Solar Gray sheet absorbs more solar energy over the entire spectrum. This energy is partially converted into heat which can be radiated inward, heating the area below the sheets. The Solar Control sheet avoids this by reflecting a much larger percentage of energy over the entire spectrum. Compare this with the small percentage of reflection by Solar Gray. Also note, that the Solar Control transmits a uniform 20% of light energy over a wide portion of the energy spectrum. Similar comparisons can be made for sheets transmitting 35% and 50% of incident light.

Optical Properties of Solar Control Sheet* with 20% Light Transmission

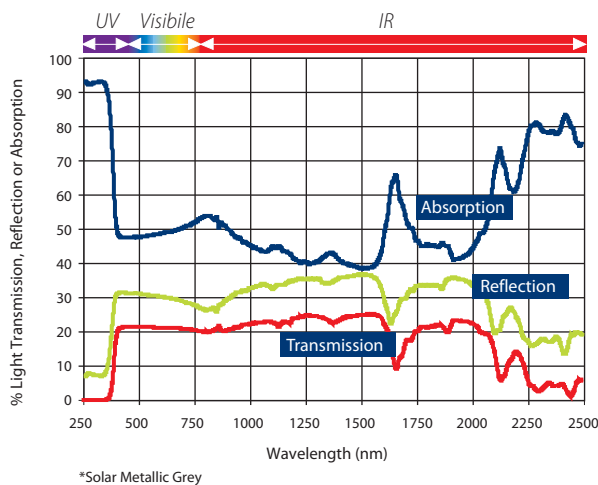

Optical Properties of Solar Gray Sheet with 20% Light Transmission

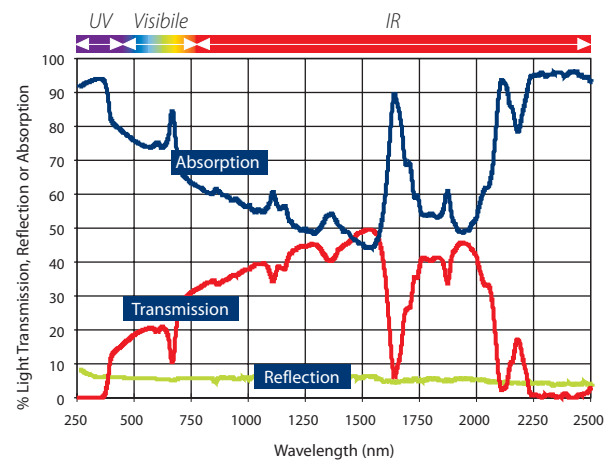

The Athens Olympic stadium roof glazed with PALSUN Solar Olympic UV2

► Weather Resistance

Though both PALSUN and PALTUF are impervious to any temperature encountered in the environment, only PALSUN will resist the affects of solar UV radiation. The changes in optical properties of a typical 3 mm PALSUN and PALTUF sheet under accelerated UV exposure (QUV) are presented in the graphs below. Note that 100 hours of QUV exposure is roughly equivalent to 1 year actual outdoor exposure in Israel or Phoenix, Arizona in the USA. The changes in optical properties of PALSUN, are not perceptible to the naked eye.

% Light Transmission of PALSUN and PALTUF Sheet as Function of QUV Exposure Hours

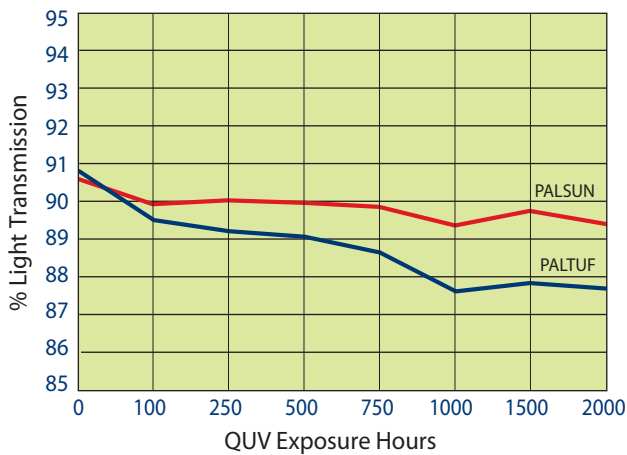

Change in Yellowness Index of PALSUN and PALTUF Sheet as Function of QUV Exposure Hours

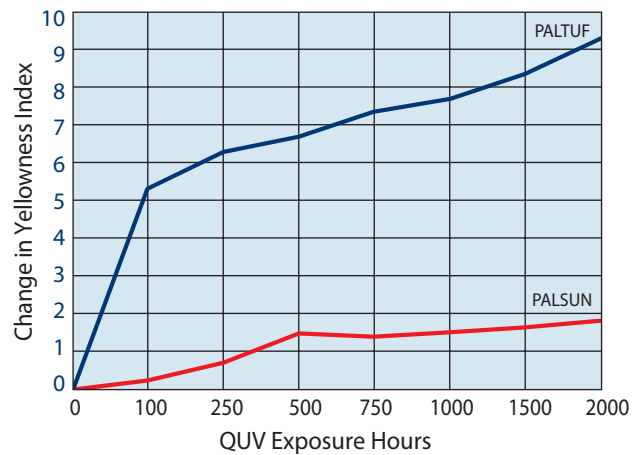

► PALSUN® Protects against the Harmful Effects of UV Radiation

Exposure to solar ultraviolet (UV) radiation is becoming a major health concern. The adverse affects were once thought to be associated with solar UV radiation in the 270 to 320 nm (UV-B) range. However, in recent years it has become apparent to exposure to UV-A (320-400 nm) is also detrimental. In addition to skin cancer, premature aging has been associated with exposure to UV-A. PALSUN sheets totally block out UV radiation in this portion of the spectrum. Almost all the UV-A radiation is also blocked out.

This almost total blockage of UV radiation can be observed in the figure below.



PALSUN is awarded by the skin cancer foundation across North-America for effectiveness in the prevention of sun-induced damage to the skin.

Comparison of Irradiance of Solar UV Radiation Through Various Protective Barriers (PF=Protective Factor)

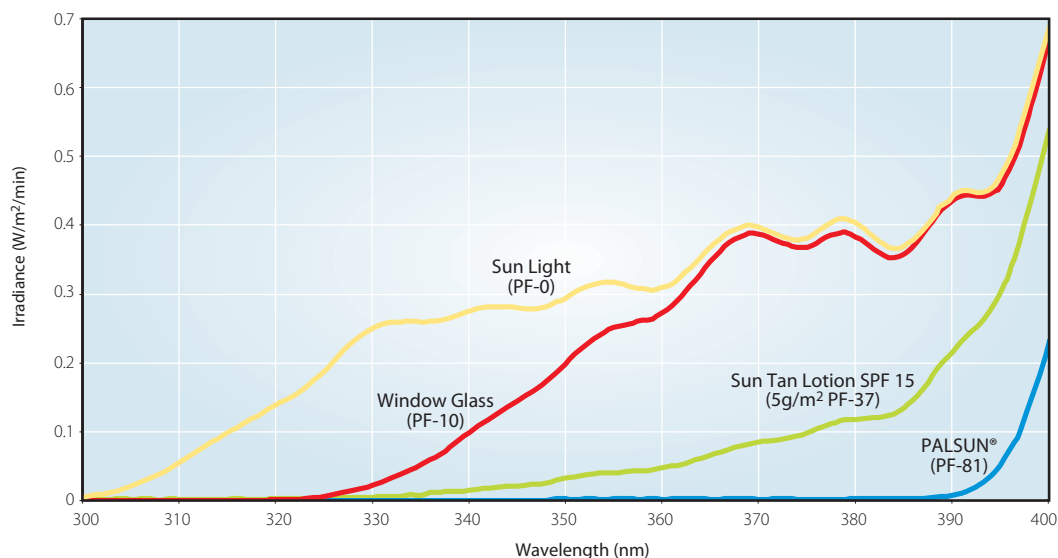

A comparison of the UV protection offered by PALSUN and that offered by sunscreen is depicted in the graph above. Note that no barrier is as effective as PALSUN sheet. Activity below PALSUN will be more protected than that offered by proper application of sunscreen, though the latter is sufficient in almost all cases. The key word in the previous sentence is proper. Improperly applied sunscreen or forgetting to apply skin screen will result in undesirable levels of exposure. In addition, note that protection factors are computed on the basis of UV-B exposure. There is as yet no way to compute protection to UV-A exposure. It should also be noted that formulations are still being marketed which only block out UV-B. When playing or swimming below PALSUN, protection is always complete. When swimming, there is no danger that the protection will be washed away.

In the last ten years, it has also been documented that UV exposure can also cause damage to the eyes, specifically to the cornea. Wearing sunglasses manufactured from polycarbonate protects the eyes. However, most people remove their glasses when entering the pool. This is a factor for both public and private pools to consider when contemplating a choice of covering.

► Thermal Characteristics

Thermal Expansion

The thermal expansion of PALSUN & PALTUF is higher than that of glass. This important factor must be taken into account when mounting the sheets.

The graph below shows the degree of dimensional change as a function of temperature.

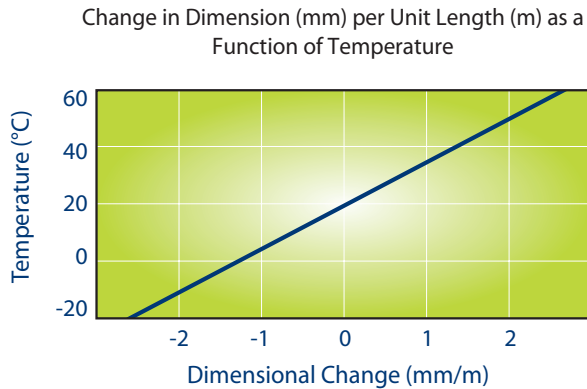

Service Temperature

The temperature range over which the characteristics of PALSUN & PALTUF are retained extends from -50°C to +100°C (-175°F to +212°F). PALSUN & PALTUF sheets are able to withstand short term exposure to temperatures up to 120°C (250°F). This range of temperatures makes PALSUN sheets suitable for use in all climates.



Thermal Insulation

On very hot days, the surface temperature of the sheet might reach up to +50°C (+122°F). The “U” value characterizes the degree of thermal transmittance offered by a given glazing material (Higher “U” values are associated with materials that are poor insulators, resulting in a greater loss of heat). The following table compares the “U” values of glass and PALSUN sheets of equivalent thicknesses. (Thicker sheets of a given material will offer greater thermal insulation and be characterized by a lower “U” value and reduced heat loss.)

For any given thickness, the “U” value of PALSUN sheet is lower than that of glass. Therefore, the heat loss from the building interior and penetration of heat or cold into a building glazed with PALSUN will be less than for one glazed with glass. This can result in a significant reduction in energy expenditure both for heating in winter and air-conditioning during the summer. Note that use of Solar Control sheets will insulate just as well and will also reduce air-conditioning costs because of less heat penetration.

Thermal Insulation of Palsun vs. Glass

Thickness mm in	PALSUN U Value (W/m ² ·°K)	Glass U Value (W/m ² ·°K)
3.0 (0.12)	5.47	5.81
5.0 (0.20)	5.19	5.72
6.0 (0.24)	5.07	5.68
8.0 (0.31)	4.84	5.60
10.0 (0.39)	4.63	5.52
12.0 (0.47)	4.43	5.45



► Other Physical Characteristics

Mechanical Characteristics

PALSUN & PALTUF maintain their mechanical properties over their entire performance temperature range. Guidelines for thickness as function of span and wind-load may be found in the appropriate tables on page 17 of this brochure.



Acoustic Properties

PALSUN & PALTUF sheets have excellent sound insulation properties as indicated in the table below. The ability to absorb sound waves together with its impact resistance, has made PALSUN the material of choice for clear highway acoustic barriers.

Thickness mm (in.)	Acoustic Insulation DIN 52210-75 RW (dB)
4 (0.16)	24
5 (0.20)	25
6 (0.24)	26
8 (0.31)	28
10 (0.39)	30
12 (0.47)	31



Weight

The specific gravity of PALSUN & PALTUF sheets is 1.2, which is about half that of glass. The following table shows the ratio between the weight of PALSUN & PALTUF sheets of various thicknesses and glass.

Weight/Area Ratio

Sheet Thickness mm (in.)	PALSUN & PALTUF kg/m ² (lb/ft ²)	Glass kg/m ² (lb/ft ²)
2 (0.08)	2.40 (0.491)	4.90 (1.00)
3 (0.12)	3.60 (0.737)	7.34 (1.50)
4 (0.16)	4.80 (0.983)	9.80 (2.00)
5 (0.20)	6.00 (1.23)	12.24 (2.51)
6 (0.24)	7.20 (1.47)	14.68 (3.00)
8 (0.31)	9.60 (1.97)	19.60 (4.01)
10 (0.39)	12.00 (2.46)	24.48 (5.01)



► Chemical Resistance

The mechanism of chemical attack on PALSUN & PALTUF differs significantly from the mechanism of corrosion of metals. Corrosion of metals results in a gradual loss of surface material as a result of electrolytic action by the relevant chemicals. In the cases where chemical attack on polycarbonate sheet occurs, all or a portion of a range of effects can be observed. Ethylene chloride, chloroform, tetrachloroethane, m-cresol, pyridene and other chemicals can cause partial dissolution of polycarbonate. Swelling agents include benzene, chlorobenzene, tetralin, acetone, ethyl acetate, acetonitrile and carbontetrachloride. Additional effects include color change and/or whitening. These effects may not always lead to product failure, especially for non-loaded sheets. Nevertheless, the level of measured mechanical properties will be reduced. The most critical effect of chemical attack is stress cracking or crazing, which may range in size from being visible to the naked eye to being only observable under a microscope. Stress cracks will always result in sheet failure which will emanate from areas of greatest stress (screws, fixings, bends, etc.)

PALSUN & PALTUF are generally not recommended for use with acetone, ketones, ethers, and aromatic and chlorinated hydrocarbons in addition to aqueous or alcoholic alkaline solutions, ammonia gas and its solutions and amines.

PALSUN & PALTUF are resistant to mineral acids, many organic acids, oxidizing and reducing agents, neutral and acid salt solutions, many greases, waxes and oils, saturated, aliphatic and cycloaliphatic hydrocarbons and alcohols, with the exception of methyl alcohol. The resistance of polycarbonate to water may be described as good up to approximately 60 °C. At higher temperatures, degradation occurs, the extent of which depends on time and temperature. Polycarbonate should therefore not be exposed for long periods of time to hot water. However, brief contact with hot water has no effect. For example, polycarbonate tableware can be washed over 1000 times in a dishwashing machine with no adverse effects being observed.

A table, which lists the resistance of polycarbonate sheet to many commonly encountered chemicals and other corrosive media at room temperature, appears in the pamphlet, "PALRAM Industries Chemical Resistance of Polycarbonate Sheets".

Adhesives and Sealants

Adhesives and sealants are often required when installing PALSUN. Detailed information on compatible adhesives and sealants can be found in the leaflet, "Adhesives and Sealants Compatible with Polycarbonate Sheets".

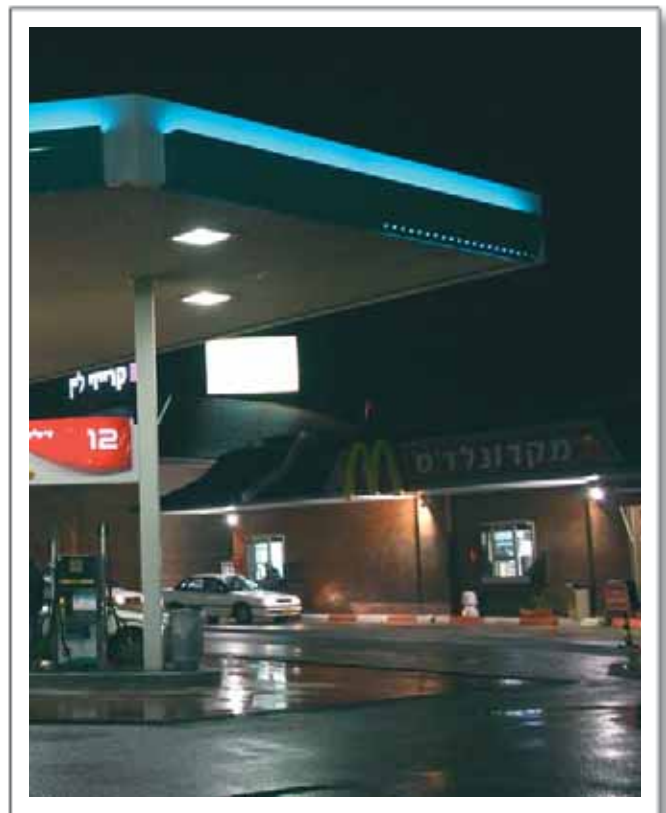
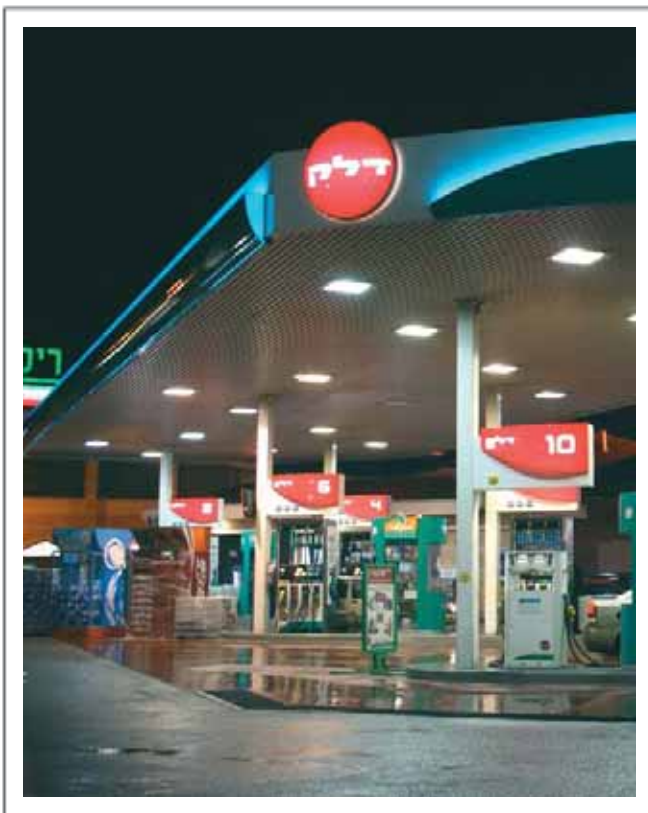

► Installation

After installing the sheet, immediately remove the protective masking. The information below is presented to assist in ordering the required dimensions.

Determination of Thickness

In order to determine the required thickness, the following table lists the sheet thickness required for a given wind load and width (at the narrow side of the sheet).

Thickness of Sheet in mm (in.) for a Given Width (Short Dimension) and Wind Load Factor

Wind Load Pa ^a or N/m ² (psi)	400 (0.06)	800 (0.12)	1200 (0.17)	1600 (0.23)	2000 (0.29)
Width mm (in.)	Thickness mm (in.)	Thickness mm (in.)	Thickness mm (in.)	Thickness mm (in.)	Thickness mm (in.)
600 (24)	3 (0.12)	5 (0.20)	6 (0.24)	8 (0.31)	10 (0.39)
800 (31)	4 (0.16)	5 (0.20)	6 (0.24)	8 (0.31)	10 (0.39)
1000 (39)	4 (0.16)	5 (0.20)	6 (0.24)	10 (0.39)	12 (0.47)
1200 (47)	5 (0.20)	5 (0.20)	6 (0.24)	10 (0.39)	12 (0.47)
1400 (55)	6 (0.24)	6 (0.24)	8 (0.31)	10 (0.39)	NS ^b
1600 (63)	8 (0.31)	8 (0.31)	8 (0.31)	10 (0.39)	NS ^b
1800 (71)	8 (0.31)	10 (0.39)	10 (0.39)	12 (0.47)	NS ^b
2000 (79)	10 (0.39)	10 (0.39)	10 (0.39)	NS ^b	NS ^b

a For wind load in kg/m², multiply value by 0.1 (e.g. 400 N/m² = 40 kg/m²)

b NS - Required thickness exceeds largest available standard thickness (12 mm or 0.47 in.).

Example:

If the wind load is 800 N/m² and the width of the sheet is 1200 mm, a sheet of 5 mm thickness should be used.

But if for the same wind-load the width of the sheet is 1600 mm, a sheet of 8 mm thickness should be used.

Determination of Sheet Size

Due to thermal expansion, PALSUN & PALTUF sheets have to be cut accurately at predetermined lengths smaller than the dimensions of the frame. At the end of the frame, clearance must be left for expansion. The diagram in the top left hand corner of page 19 and the tables below explain how to calculate the required sheet dimension. In addition, there is a table showing the expansion clearance necessary for various sizes of PALSUN & PALTUF sheets.

Recommendations for Cutting PALSUN® & PALTUF™

("c" and "d" refer to the indicated dimension in the diagram in the top left hand corner of page 19).

If sash dimension "c" or "d" is:	Trim PALTUF/PALSUN by:
300 mm (11.8 in.)	1 mm (0.04 in.)
300 mm (11.8 in.) - 700 mm (27.6 in.)	2 mm (0.08 in.)
700 mm (27.6 in.) - 1000 mm (39.4 in.)	3 mm (0.12 in.)
1000 mm (39.4 in.) - 1300 mm (51.2 in.)	4 mm (0.16 in.)
1300 mm (51.2 in.) - 1700 mm (66.9 in.)	5 mm (0.20 in.)
1700 mm (66.9 in.) - 2000 mm (78.7 in.)	6 mm (0.24 in.)
2000 mm (78.7 in.) - 2300 mm (90.6 in.)	7 mm (0.28 in.)
2300 mm (90.6 in.) - 2700 mm (106 in.)	8 mm (0.31 in.)
2700 mm (106 in.) - 3000 mm (118 in.)	9 mm (0.35 in.)

Sheet Thickness Required for Given Sheet Width* and Rabbet Depth ("a" and "e" refer to the indicated dimensions in the diagram at the top of page 19.)

Width* (a)	Thickness	Rabbet Depth (e)
700 mm (28 in.)	3 mm (0.12 in.)	15-20 mm (0.6 - 0.8 in.)
900 mm (35 in.)	4 mm (0.16 in.)	15-20 mm (0.6 - 0.8 in.)
1100 mm (43 in.)	5 mm (0.20 in.)	15-20 mm (0.6 - 0.8 in.)
1300 mm (51 in.)	6 mm (0.24 in.)	20-30 mm (0.8 - 1.2 in.)
1500 mm (59 in.)	8 mm (0.31 in.)	20-30 mm (0.8 - 1.2 in.)
1700 mm (67 in.)	10 mm (0.39 in.)	20-30 mm (0.8 - 1.2 in.)
1900 mm (75 in.)	12 mm (0.47 in.)	20-30 mm (0.8 - 1.2 in.)

*Width refers to the smaller dimension.



► Installation

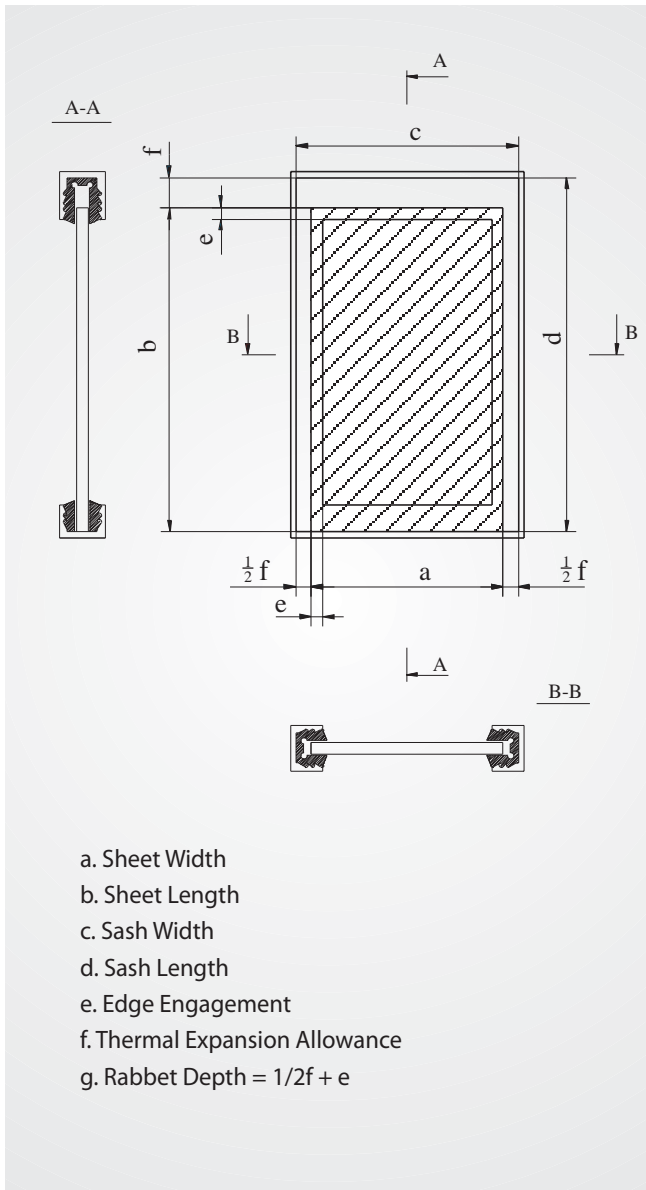

Choice of the Frame

PALSUN & PALTUF sheets can be mounted in most existing frames made of wood, rigid PVC, aluminum or other metals. It is recommended to use neoprene or EPDM packing (never use soft PVC) to secure the sheet in its frame, rather than fixing with screws.

Butyl rubber sealing strip or silicone sealant (PALRAM has tested and recommends Dow Corning Q3-7098 or Q3-3793 and Novasil S 64) are also permissible. A list of compatible adhesives and sealants appears on the leaflet, "Adhesives and Sealants Compatible with Polycarbonate Sheets".

Mechanical Fastening

PALSUN & PALTUF sheets can be fastened with nuts and bolts, providing that several points be kept in mind:

- Never use rivets - they apply too much force and may cause cracks in the sheets.
- Always drill a slightly over-sized hole to compensate for thermal expansion.
- Never use soft PVC washers!
- Use neoprene and aluminum washers to distribute the load.
- When using mechanical fasteners, they should be evenly spaced to avoid stress accumulation at particular points.
- With nuts and bolts, tighten moderately and use only rust-free materials.
- Wherever possible, a "floating sheet in frame" is preferable, similar to glass, and without mechanical drilled fasteners.

Treatment of Sheets after Installation

The polyethylene masking must be removed immediately after installation. The polyethylene masking covers the sheet to protect it during handling, storage, and installation. If it is removed at a later date (In hot climates, even 24 hours after installation is completed may be too late), it will be very difficult if not impossible to remove.

PALSUN & PALTUF sheets may be cleaned by carefully following the instructions on page 20.



► Working With PALSUN® & PALTUF™

PALSUN & PALTUF can be cut, sawed, drilled, bent (hot or cold), bonded and thermoformed. Detailed instructions appear in the "PALSUN Technical Manual".

Cleaning

PALSUN & PALTUF sheets can easily be cleaned with a soft cloth made from 100% cotton using generous amounts of detergent and water. It is best to use mild dish cleaning preparations. Commercial spray cleaners are available. Please consult with your local PALRAM agent or representative for recommended commercial preparations available locally.

Sawing and Cutting

PALSUN & PALTUF sheets can be cut with bandsaws, handsaws, circular saws and other cutting tools. (Refer to the "PALSUN Technical Manual".) Notwithstanding the multiple possibilities, the table below indicates the cleanest cutting options.

	Circular Saw	Bandsaw
Clearance Angle	20-30°	20-30°
Flake Angle	15°	0.5°
Cutting Speed	180-250 m ³ /min (590-820 ft ³ /min)	200-250 m ³ /min (650-820 ft ³ /min)
Blade or Band Speed	1800-2400 m ³ /min (5900-7870 ft ³ /min)	600-1000 m ³ /min (1970-3280 ft ³ /min)
Tooth Spacing	2-5 mm (0.08-0.2 in.)	1.5-2.5 mm (0.06-0.10 in.)

For single sheets of less than 3 mm (0.12 in.) thickness, bandsaws, routers or shears are preferable to circular saws.

Bonding

It is possible to bond PALSUN & PALTUF sheet to itself and to other materials. Please consult the "PALSUN Technical Manual" (Available at PALRAM website).



PALSUN Fabricated Door Sign

► Working With PALSUN® & PALTUF™

Bending

Cold Bending

PALSUN & PALTUF sheets may be installed with a stressed curve to create an arch or dome, as long as the curve and resulting stress is within the specified limits. This stress will fall within an acceptable limit and there will be no effect on the sheet characteristics if the magnitude of the radius is at least 200 times that of the sheet thickness, as indicated in the following table.

Radius Desired mm (in.)	Thickness Required mm (in.)
600 (24)	3 (0.12)
800 (31)	4 (0.16)
1000 (39)	5 (0.20)
1200 (47)	6 (0.24)
1600 (63)	8 (0.31)

Hot Line Bending

If the polyethylene masking was removed before processing, verify that the sheet is clean. If not, clean following the instructions at the bottom of the next column.

Using this method, PALSUN or PALTUF sheet is locally heated to 150-160 °C (300-320 °F) with a radiation heater (e.g. electrical resistance wire). When using single-sided heating, the sheet must be turned over several times. After heating, the sheet is bent to the desired angle.

Due to immediate relaxation during bending and in order to obtain the desired angle, an overbend might be required in hot line bending.



Stress Level

Both cold and hot bending (if the sheet is not heated sufficiently) PALSUN & PALTUF sheet induces stress in the sheet. The residual stresses will reduce the impact strength of the material along the bend and may limit the use of this method to less demanding applications. Almost completely stressless bends may be obtained using the annealing method (heating of the bent sheet).

Thermoforming

PALSUN & PALTUF sheet intended for thermoforming with masking must be ordered specially and is supplied with a polyethylene masking intended for thermoforming. This masking will not be printed or labeled except for ink jet along the edge because printing affects the optical quality of the thermoformed article.

Thermoforming machines vary in their performance. It is essential that you test PALSUN & PALTUF sheets with masking in your thermoforming process before starting production.

If PALSUN & PALTUF sheet intended for thermoforming was not ordered, or if this is not stated on the packing slip, then the polyethylene masking must be removed prior to thermoforming. In this case, verify that the sheet is clean prior to processing. If necessary clean the sheet following the instructions on page 20. Working in a dust free environment is also required.

PALSUN & PALTUF sheet must be pre-dried prior to thermoforming. Detailed instructions for pre-drying and thermoforming appear in the "PALSUN Technical Manual".

Important!

Sheets intended for thermoforming are supplied with a special polyethylene masking. Please specify when ordering PALTUF or PALSUN for thermoforming.

► Additional PALRAM Semi-Finished Products

Flat

SUNLITE®

Multiwall (structured) polycarbonate sheet, co-extruded with UV protection on one or two sides. Available with multi-layered colouring, advanced solar properties, anti-condensation treatment and more.

PALCLEAR™

Flat rigid clear PVC sheets with the following options: standard, HI (High Impact), UV protection on one side, UV protection on one side for thermoforming, or embossed (prismatic 12).

PALGLAS®

Flat rigid extruded solid acrylic sheet with up to 92% light transmission.

PAL-G™

Flat rigid standard or UV protected (one side) co-polyester sheets.

PALIGHT®

Flat foamed PVC sheet that features lightweight, durable and versatile surfaces which can be painted, printed or milled, according to customer specifications. The new generation PALIGHT offers bright white and improved surface quality for true colour interpretation.

COMPAX™

Flat rigid matte opaque modified polycarbonate sheet for thermoforming without pre-drying.

PALOPAQUE™

Flat rigid opaque PVC sheet with the following options: glossy, matte, UV protection, UV protection for thermoforming.

PALDOOR™

Flat rigid matte PVC sheet for thermoforming door panels.

Corrugated

SUNTUF®

Corrugated polycarbonate sheet with co-extruded UV protection on one or two sides, and optional anti-condensation treatment, embossed surface, advanced heat blocking and standard or tailor-made profiles.

SUNTOP®

Corrugated foam polycarbonate sheets in rounded profiles with co-extruded UV protection on one side.

PALRUF®

Corrugated rigid PVC sheet with the following options: clear, translucent or opaque, with or without additional UV protection, HI (High Impact), standard or tailor-made profiles.

SUNGLAS™

Attractive and durable corrugated sheet extruded from high impact acrylic, transmits over 90% of incident light with a honeycombed or prismatic embossed surface.

EPSE



Inasmuch as PALRAM Industries has no control over the use to which others may put the material, it does not guarantee that the same results as those described herein will be obtained. Each user of the material should make his own tests to determine the material's suitability for his own particular use. Statements concerning possible or suggested uses of the materials described herein are not to be construed as constituting a license under any PALRAM Industries patent covering such use or as recommendations for use of such materials in the infringement of any patent. PALRAM Industries or its distributors cannot be held responsible for any losses incurred through incorrect installation of the material. In accordance with our company policy of continual product development you are advised to check with your local PALRAM Industries supplier to ensure that you have obtained the most up to date information.



EUROPE

PALRAM EUROPE LTD.

Tel ► (44) 1302 380 776

Fax ► (44) 1302 380 788

sales.europe@palram.com

PALRAM UK

Tel ► (44) 1302 380 738

Fax ► (44) 1302 380 739

sales@palram.co.uk

USA

PALRAM AMERICAS

Tel ► (1) 610 285 9918

Fax ► (1) 610 285 9928

palramamericas@palram.com

ISRAEL

PALRAM ISRAEL LTD.

Tel ► (972) 4 8459 900

Fax ► (972) 4 8459 980

palram@palram.com

61303-05.07

Europe
UK
Israel
USA
Australia
Far East

www.palram.com